

MX3.0连接器承认图面

REV	SYM	REVISION RECORD	DR.	APPR.	DATE
A/0		原始版本			A/0
A/1					
A/2		Part No. 由MX3.0-NY改为MX3.0-1XNY			20190921
A/3		新增C3001-HB系列			20190924

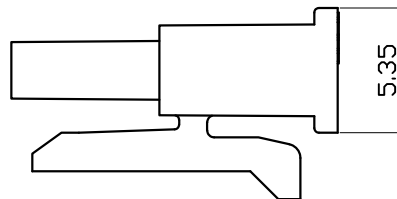

C3001-HB03~12

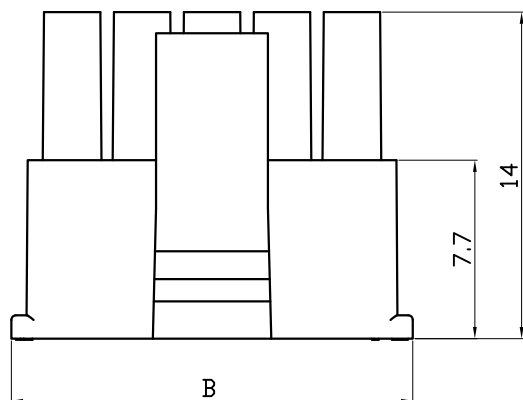
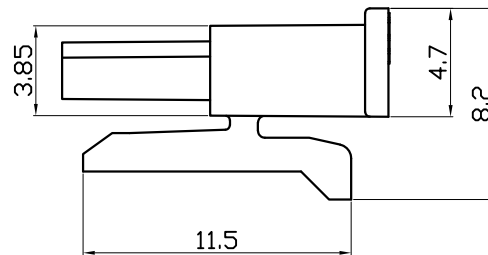
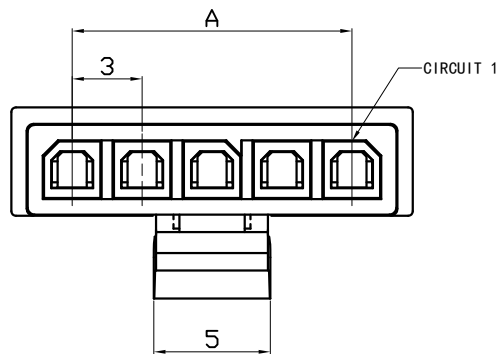
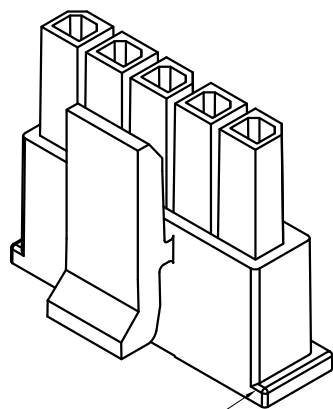

C3001-H系列
左右有抓手

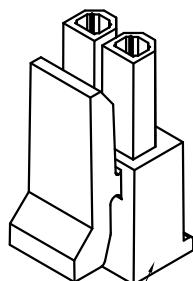

C3001-HB02
左右上均无抓手

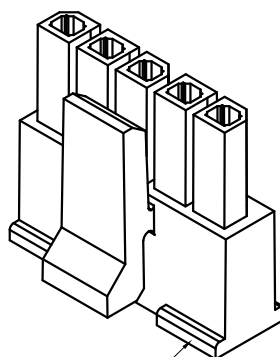

C3001-HB03~12
此处有抓手

Poles	Part NO.		Dimensions mm	
	A	B	A	B
2	C3001-H02	MX3.0-2Y	3.00	8.20
3	C3001-H03	MX3.0-3Y	6.00	11.20
4	C3001-H04	MX3.0-4Y	9.00	14.20
5	C3001-H05	MX3.0-5Y	12.00	17.20
6	C3001-H06	MX3.0-6Y	15.00	20.20
7	C3001-H07	MX3.0-7Y	18.00	23.20
8	C3001-H08	MX3.0-8Y	21.00	26.20
9	C3001-H09	MX3.0-9Y	24.00	29.20
10	C3001-H10	MX3.0-10Y	27.00	32.20
11	C3001-H11	MX3.0-11Y	30.00	35.20
12	C3001-H12	MX3.0-12Y	33.00	38.20
2	C3001-HB02	MX3.0-2YB	3.00	6.90
3	C3001-HB03	MX3.0-3YB	6.00	9.90
4	C3001-HB04	MX3.0-4YB	9.00	12.90
5	C3001-HB05	MX3.0-5YB	12.00	15.90
6	C3001-HB06	MX3.0-6YB	15.00	18.90
7	C3001-HB07	MX3.0-7YB	18.00	21.90
8	C3001-HB08	MX3.0-8YB	21.00	24.90
9	C3001-HB09	MX3.0-9YB	24.00	27.90
10	C3001-HB10	MX3.0-10YB	27.00	30.90
11	C3001-HB11	MX3.0-11YB	30.00	33.90
12	C3001-HB12	MX3.0-12YB	33.00	36.90

1	Housing	PA66 (UL94V-0)	1	Black	
序号	图号	名称	材料	数量	附注
未注公差		LHE ® 浙江联和电子有限公司 ZHEJIANG LIANHE ELECTRONICS CO., LTD			
X.° ±3° X.X° ±0.5°					
>0-3	>3-18	>18-50	>50-120	单位	比例
±0.12	±0.15	±0.3	±0.5	MM Only	DESIGN UNITS METRIC
制作	审核	批准	材料	图号	页码
			见图解	品名	Part No.
					MX3.0-NY

旧底图总号
底图总号
签字
日期